

# ***ELECTRAPLAN*** **(PTY) LTD.**

***ELECTRAPLAN PRODUCT RANGE***

*Electraplan has been supplying floor service outlets and powersets to both the South African and international markets since its inception in 1990.*

*Our complete product range is designed and manufactured by Electraplan. All products carry a six month guarantee.*

*Electraplan Powerset unit are the safe and easy way of providing a unique reticulation system. They are flexible, simple and economical. Powersets are available in two different styles and four different sizes. They support a variety of socket components offering you unlimited versatility and display combinations. They can be added to and re-arranged at any stage and can be adapted to suite your needs of the day.*



**ELECTRAPLAN**  
(PTY) LTD.

**EP8000 POWERSETS**

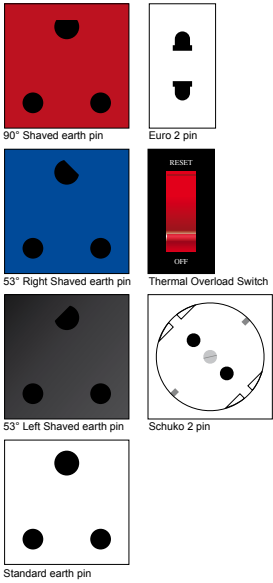

*Two socket system dimensions*

221mm long  
38mm high  
56 mm wide

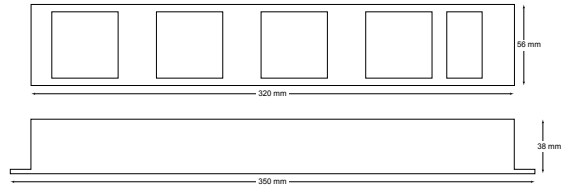

*Four socket system dimensions*

350mm long  
38mm high  
56 mm wide

*Powersets are wired with three different cable options*

- 1,0mm<sup>2</sup> cable - 10amp - kettle connectors
- 1,5mm<sup>2</sup> cable - 16amp - locking devices
- 2,5mm<sup>2</sup> cable - 20amp - locking devices

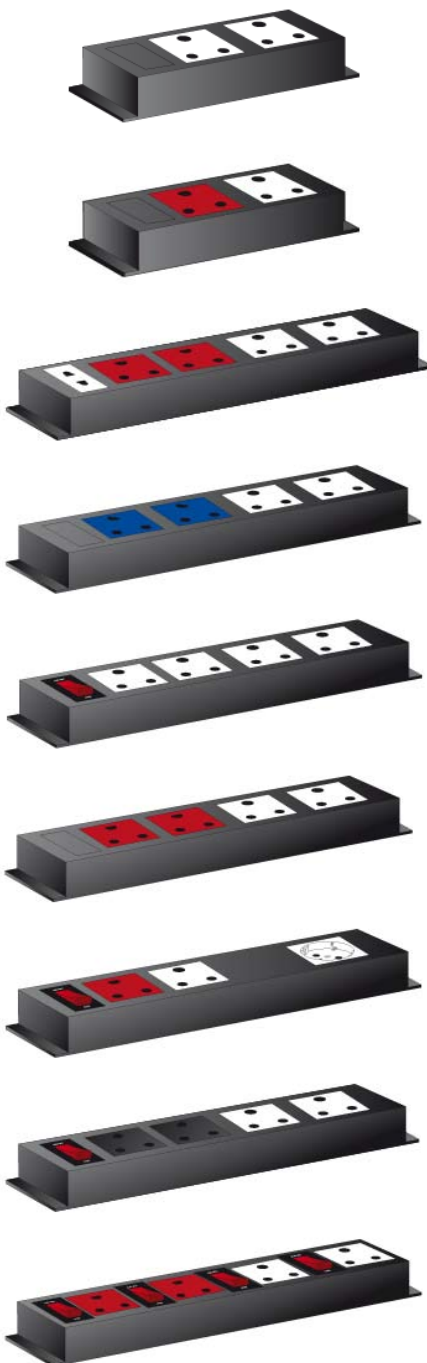
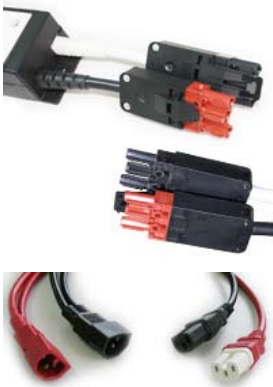

*2 White*

*1 Red, 1 White*

*2 Red, 2 White, 1 Euro*

*2 Blue, 2 White*

*4 White With Overload Switch*

*2 Red, 2 White*

*Overload Switch, 1 Red, 1 White, 1 2 Pin*

*Overload Switch, 2 Black, 2 White*

*2 Red, 2 White, With Individual Switches*

## EP6000 POWERSETS

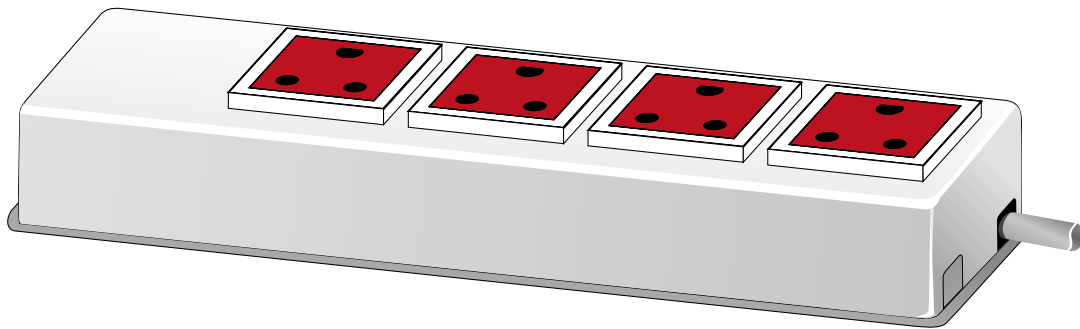

### Dimensions

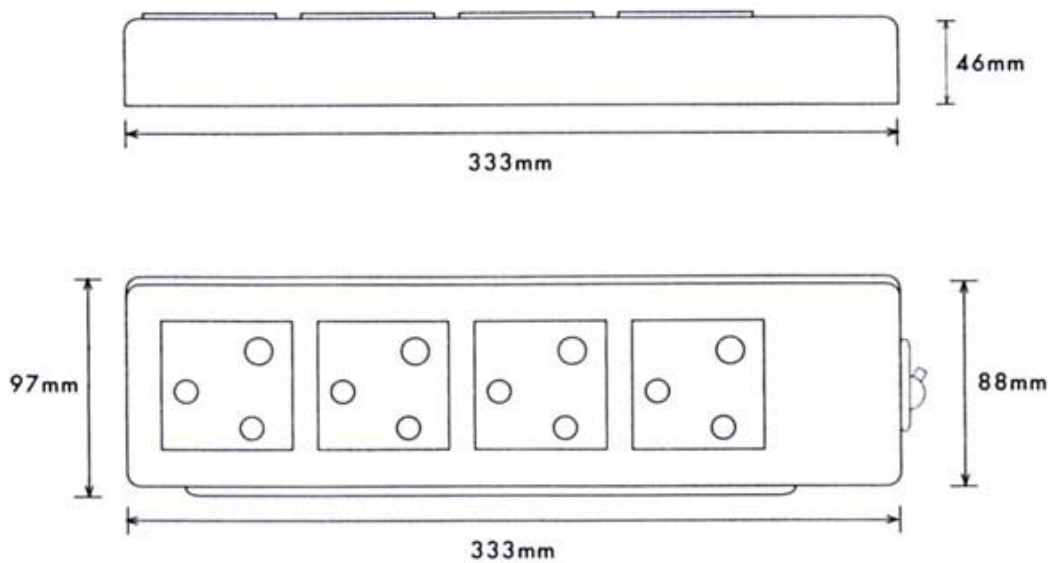

*Powerset 6000 is a four socket system. The system is available*

*With 5, 10, 15 and 20 amp circuit breakers  
With indicator light*

### Plugtops and sockets

Available in:

Red (Clean)  
White (Standard)  
Black (UPS)  
Blue (Generator)

Catalogue number (EP6000) must be followed by:

R = Red - 90° Shaved earth pin on plug top

W = White - Standard earth pin on plug top

B = Black - 53° Left Shaved earth pin on plug

B = Blue - 53° Right Shaved earth pin on plug

## FSO1000 ACCESS FLOOR

### Access covers

Single and double pop-up access covers are available. All covers have a perimeter wall for ease of gluing carpet in position, ensuring a neat carpet installation.

### Standard Access covers

Locks into main housing  
Rotates through 360°  
Pop-up cable outlet

### Drill hole in the tile: 198mm



Single pop-up access cover



Double pop-up access cover

Locks into main housing  
Rotates through 360°

### Services plate and housing

The Services plate is fixed into the Services housing. Its design allows for a number of electrical combinations due to a system of dividers. Dividers act as an electrical safety barrier by separating the high voltage service from the low voltage services.

### Main housing

The main housing fits through the hole in the floor tile allowing the slim profiled perimeter lip to rest neatly on the carpet.

### Locking ring

The locking ring enables F.S.O. to be secured quickly and efficiently into the floor tile regardless of the underneath profile of the tile.

### Dimensions

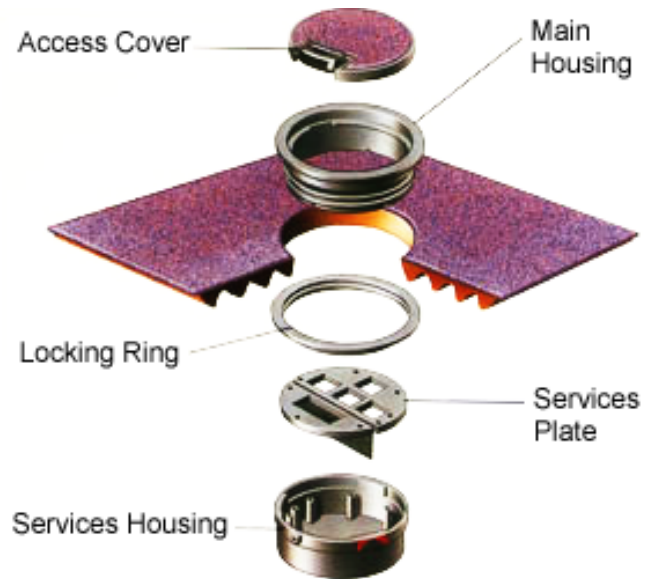

### Easy installation

- Fit the main housing through the hole in the floor tile and secure below with the locking ring.
- The services housing bayonette fits onto main housing in one simple movement.
- Lastly, lock an access cover into the main housing for a neat, flush finish.
- No tools required for installation
- The total system is maintenance friendly
- This design affords quick and easy maintenance or re-allocation with a minimum of downtime.

The excellent electrical properties of the Floor Services Outlet in combination with its mechanical strength, heat deflection, dimensional stability and fire performance are special features in its design.

# FLOOR BOXES AND JUNCTION BOXES

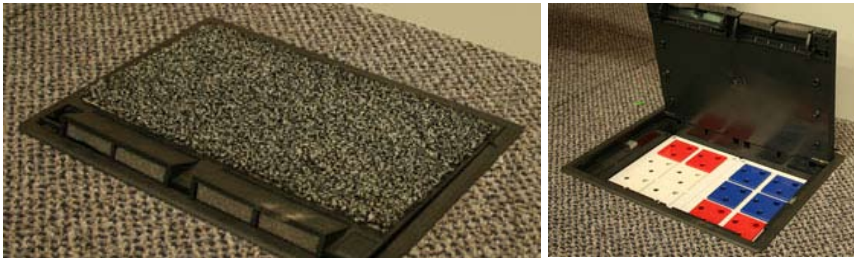

### Specifications

- Boxes and junction boxes for installation in all types of floors
- Available in 1, 2, 3, 4 and 6 108 x 52 mm modules
- Two basic finish colours: Grey (RAL 7011) and Graphite grey (RAL7021)
- Hinged, exchangeable covers with safety locks
- Tilting cable outlet with safety stop, preventing the cables from being damaged by people standing on them
- Boxes with adjustable depth
- Available with two different depths (raised floor or ground)
- Manufactured with fireproof and halogen-free materials
- Pre-punched inputs for trunkings and pipes
- Enables the incorporation of protection elements
- Separating partition between power mechanisms and Voice, Data and Multimedia (VDM) mechanisms
- Wide range of power sockets and voice and data plates compatible with almost all the RJ45 connectors on the market.



Junction box cover

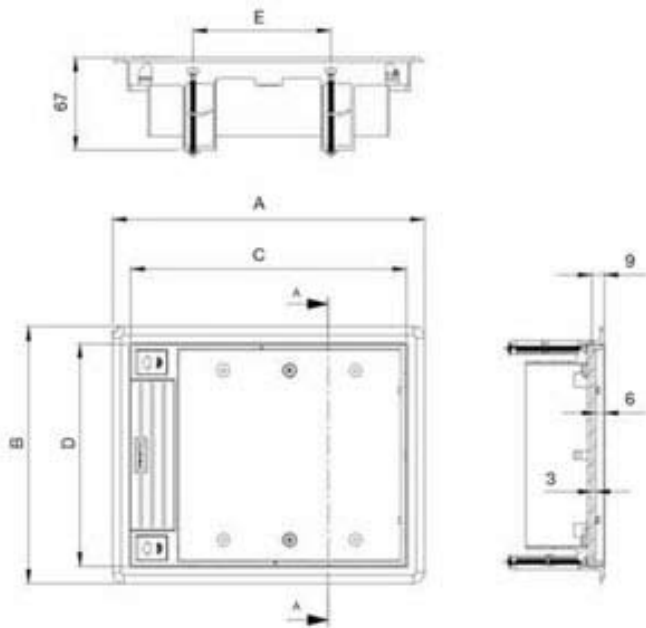

Plastic junction boxes

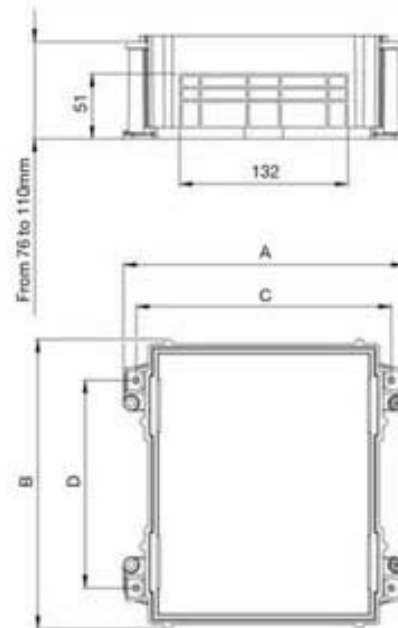

References	Dimensions				Space measurements
	A	B	C	D	
S110	132	187	108	163	170x115
S210	171	187	147	163	170x155
S310	226	186	202	163	170x209
S410	283	187	257	163	170x266
S610	319	226	202	268	209x302

References	Dimensions			
	A	B	C	D
G11	220	165	200	129
G22	220	172	200	129
G33	220	227	200	163
G44	220	287	200	240
G66	259	313	239	256

N.B.  
S110, S210, S310, S410 and S610 floor boxes,  
depth 93 mm adjustable to 128 mm.

S170, S270, S370, S470 and S670 floor boxes,  
depth 93 mm adjustable to 128 mm.

## EP5000 TELEBLOCK



### Specifications:

- Fast open Push & Pull system
- Sections manufactured in anodised aluminium
- Mounting of 45 x 45 mm direct clip-mounting mechanisms
- These 3 models are supplied with Schuko sockets and with graphite grey or aluminium finishes
- Supplied in 2 finishes: graphite grey and aluminium

Drill hole size into desk: 102mm

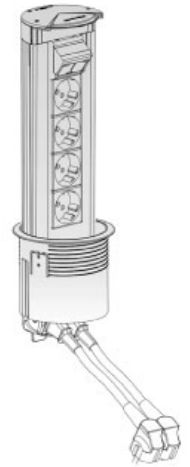

## EP2000 AIRCON GRILLE

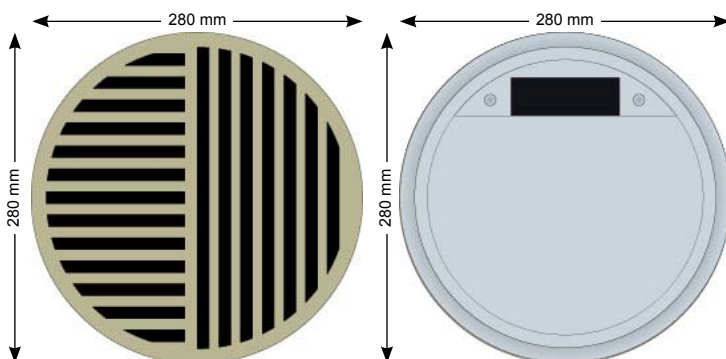
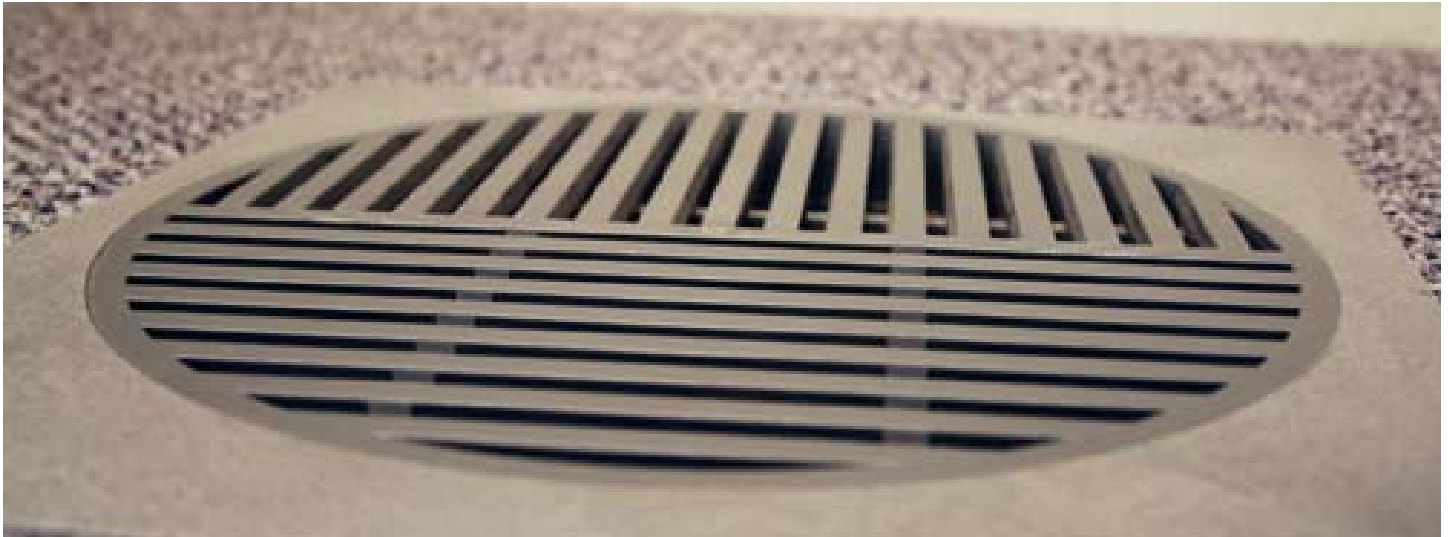

## EP4000 BRASS OUTLET

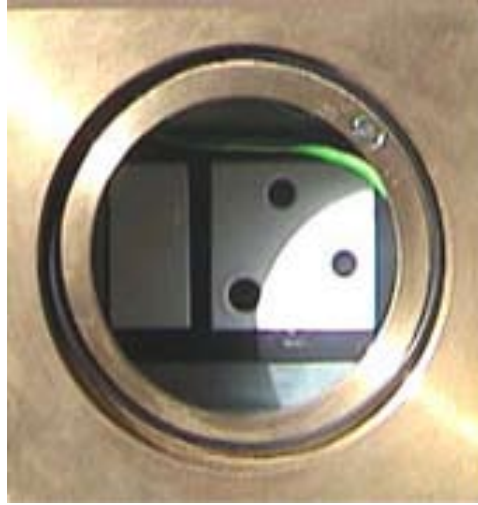

Dimensions:

Width: 160mm x 130mm

Height: 100mm

## EP3000 WATERTIGHT BOX

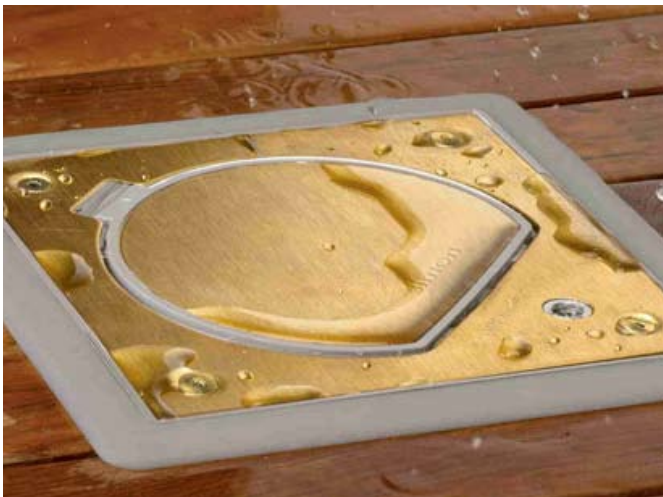

The EP3000 is designed for indoor and outdoor installations. It provides full protection against the elements and is designed to withstand a 1kg/cm<sup>2</sup> jet of water from any direction.

Available in stainless steel or brass finishes.

Raised floor Tray

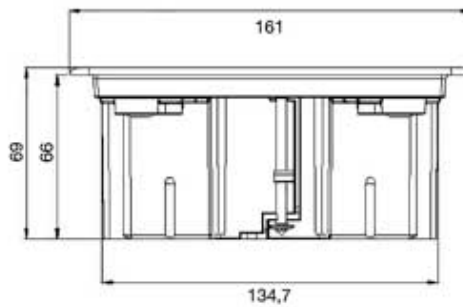

Box installation depth

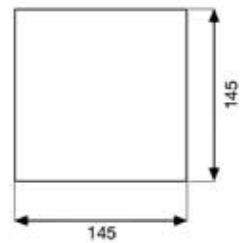

Paving Tray

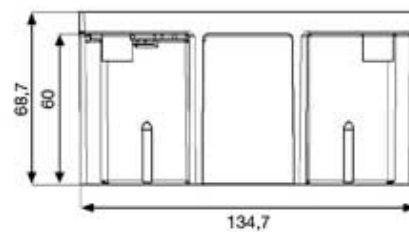

Box installation depth

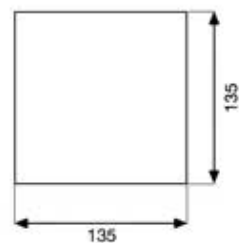

## POPUP POWER



POPUP POWER is a retractable service unit that provides electricity, water and air supply to public spaces ranging from historic sites and market places to town squares and parks. POPUP POWER retractable service units provide legacy for special-purpose stadiums. They offer possibilities for more varied uses, giving stadiums new life long after their planned functions.

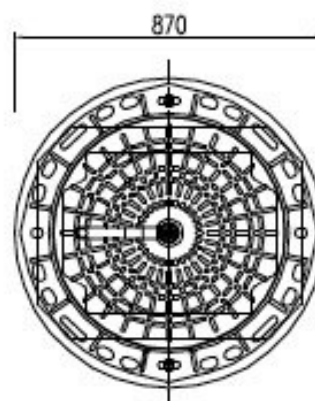
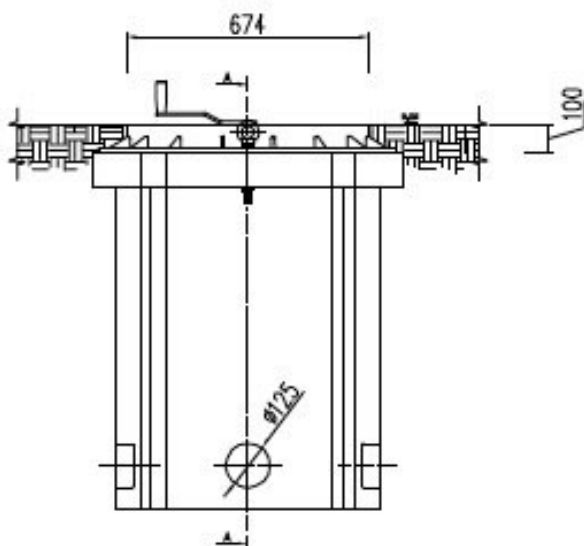
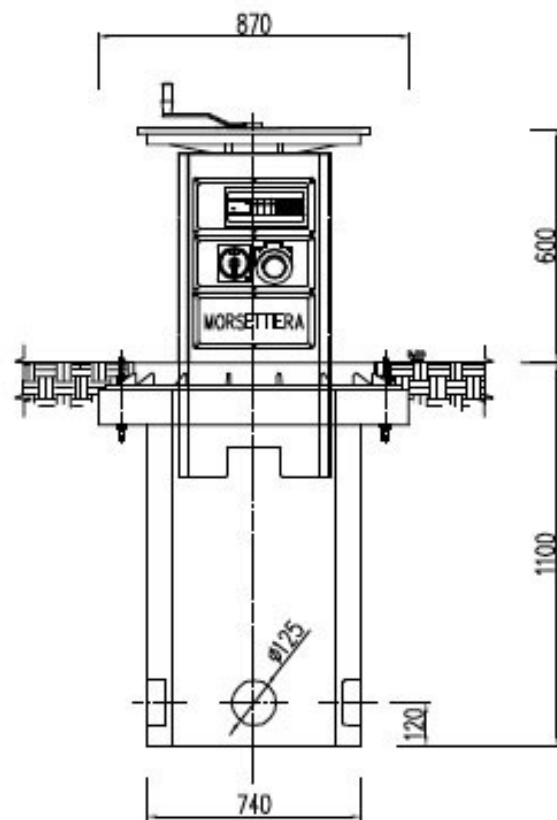
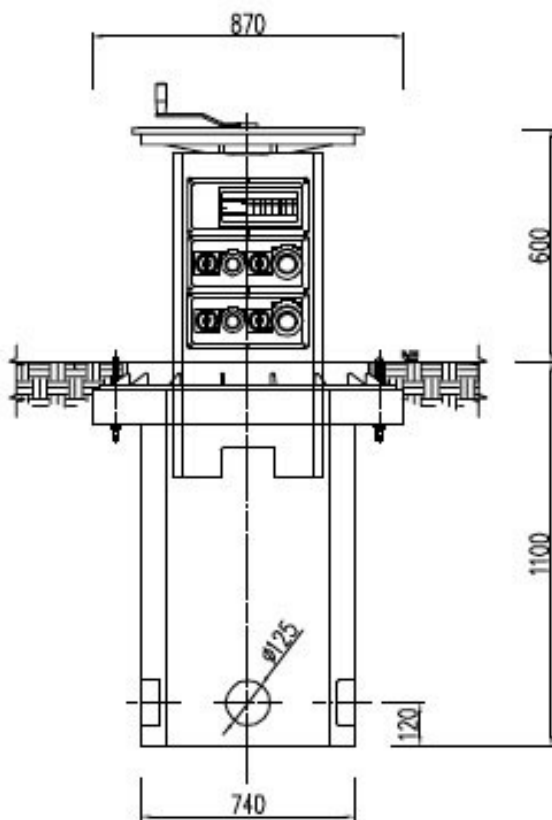

**POPUP POWER**

